



**LK STINGER 4016**  
4,000 lbs. Lifting Capacity  
Hydraulic/Electric-Hydraulic Service Crane

# STINGER 4016



## Features: LK STINGER 4016 H/EH

- 4,000 lbs. @ 2 ft. 2 in.
- 16,000 ft.-lbs. (2.21 ton-m) Crane Rating
- 16 ft. max boom length
- Hydraulic overload protection
- Quick release hook stow
- Square boom design

# DIMENSIONS

# STINGER 4016

## Example Layout Drawing

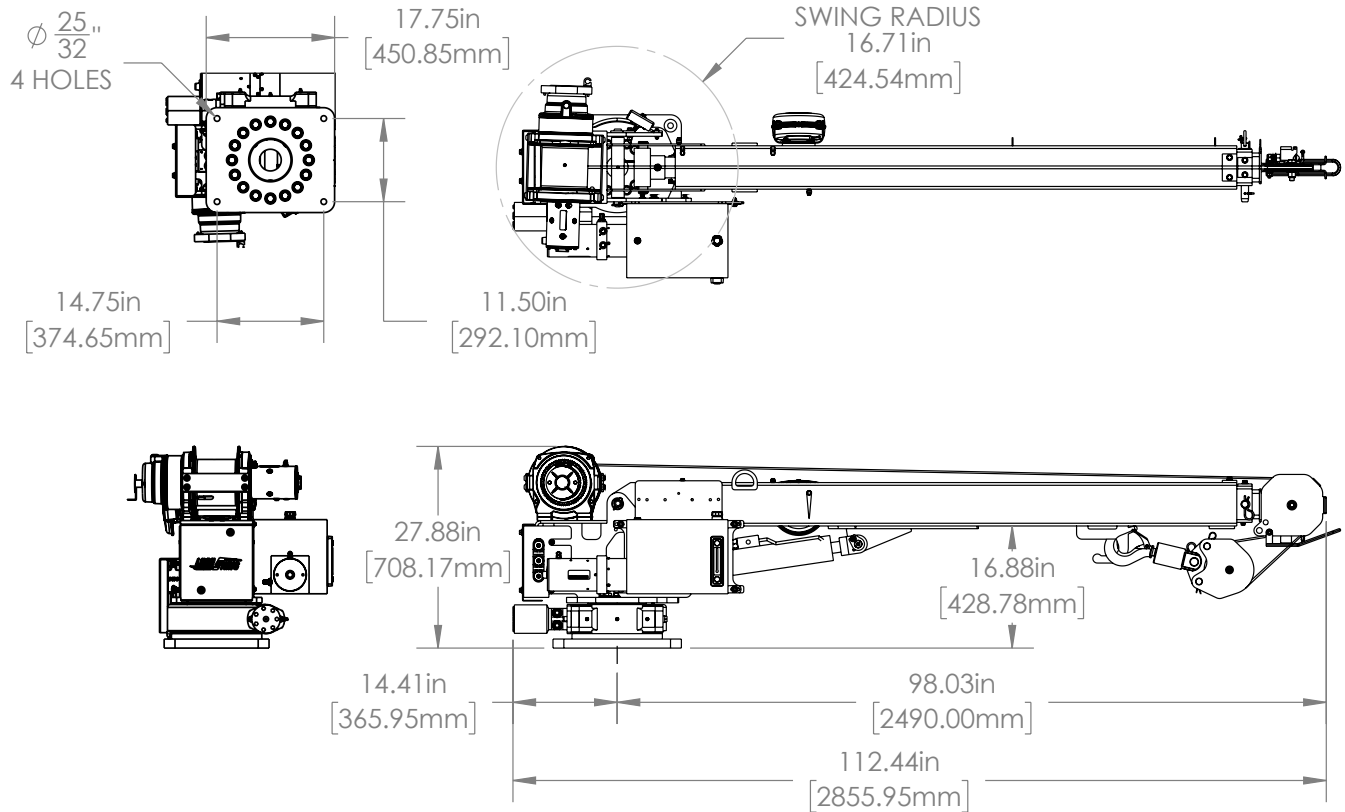

## Common Specifications

Minimum Gross Vehicle Weight Rating .....	10,500 lbs.
Load line .....	5/16" IWRC x 80 ft. (5.56 mm x 18.9 m)
Storage height .....	27 7/8" (0.71 m)
Storage length .....	9' 4" (2.86 m)
Mounting plate .....	1 1/4" thick (31.8 mm)
Bolt pattern .....	14.75" x 11.50" (375 mm x 292 mm)
Base plate dimensions .....	14.50" x 17.75" x 1.25"
RBM per Frame Rail .....	210,600 lb.-in.
Voltage (Electric/Hydraulic version) .....	2 x 12 V DC
Alternator (Electric/Hydraulic version) .....	75 Amp minimum cold-cranking amps
Pump (Hydraulic version) .....	5 gpm @ 2,100 psi
Paint .....	White powder coat

# RANGE DIAGRAM

Stabilizers Fully Extended

# STINGER 4016

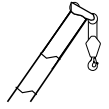

## 4016

ANSI B30.5

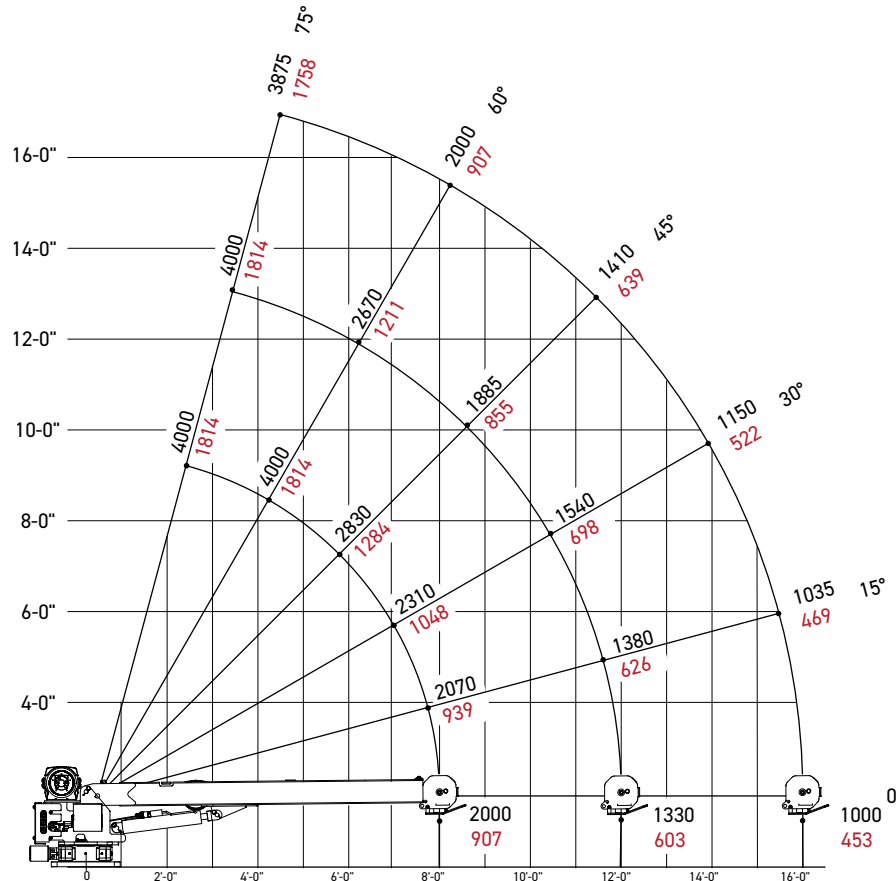

Loads are shown in pounds in black  
Kilograms are shown in red

Horizontal reach . . . . .	16' 0"
Hydraulic extend . . . . .	48"
Manual extend . . . . .	48"
Crane weight . . . . .	875 lbs.
Center of gravity . . . . .	17" 6"
Max capacity at max reach . . . . .	1000 lbs.

## Notes to lifting capacity





Lifting capacities do not exceed 85% of tipping load. Weight of hook blocks and slings are part of the load, and are to be deducted from the capacity ratings. Consult operation manual for further details.

Note: Data published herein is intended as a guide only and shall not be construed to warrant applicability for lifting purposes. Crane operation is subject to the computer charts and operation manual both supplied with the crane.





# TECHNICAL DESCRIPTION

## STINGER 4016

### Boom and Rotation

	Three section square boom sections Boom elevation angle range (min/max)	-5° / 75°
	Boom length	16 ft.
	370 degree non-continuous rotation with electromechanical stop	
	Rotation Patented hydraulic motor driven hourglass worm gear swing drive	
	Quick hook stow	

### Operator Controls and Operator Aid

	Winch line pull (1st layer)	2,425 lbs.
	Winch line speed (3rd layer)	30 ft./min
	Rope	80 ft. of 5/16" IWRC
	Radio remote control with radio elimination cable	
	Hydraulic overload protection system	

## Stabilizers

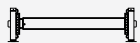

Manual out and down rear stabilizers

10' 10"

# FEATURES & BENEFITS

## STINGER 4016

### Transmitter Controls



FEATURE	BENEFIT
Boom Extension: 16 ft.	4016H: Single Proportional Hydraulic Control 4016EH: Non-Proportional On/Off Control
Square Boom Sections	Self centering booms with less deflection and increased strength
Boom Articulation from -5° to +75°	Large boom angle range
Stabilizer System Design	SS vertical cylinder jack; CS out and down cylinder with adjustable mounting height.
Hook Block A2B Interlock Control	Easy stow and stops winch function to protect wire rope
Hydraulic planetary winch	Quick line speed and high duty cycle
370° Hydraulic Rotation System	Durable, robust, sealed rotation bearing system
Wireless Remote Control w/ Radio Elimination Cable	Allows crane to work without digital signal when necessary
Powder Coated Corrosion Prevention Finish	Durable, primer and top coat finish for corrosion prevention
Compliant with ANSI B30.5	Meets and exceeds industry standards
Manufactured in Kansas City, MO	Made in the USA
Warranty	5 Year Structural / 2 Year All Components

# LOCATIONS

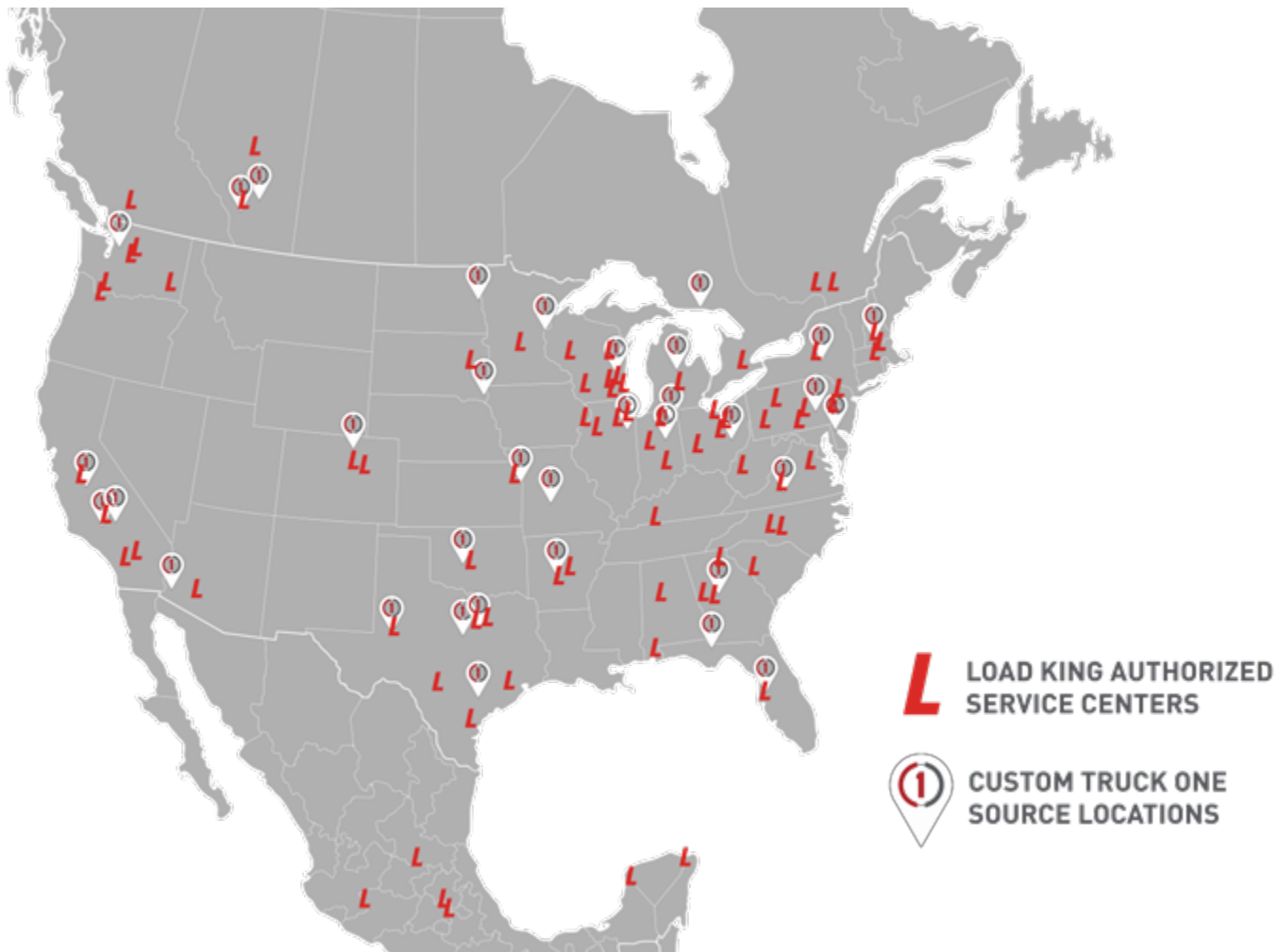

24/7 CALL CENTER  
833-281-7911

PARTS QUESTIONS  
833-PARTSLK (833-727-8755)  
PARTSSUPPORT@LOADKINGMFG.COM

PARTS ORDERS  
STORE.LOADKINGMFG.COM

WARRANTY  
CRANEWARRANTY@LOADKINGMFG.COM

All our new cranes are backed by an industry-leading 2-year basic and 3-year structural warranty

[www.loadkingmfg.com](http://www.loadkingmfg.com)

